

FOR WARRANTY REPLACEMENT THIS TASK MUST BE PERFORMED BY A TEXTRON SPECIALIZED VEHICLES AUTHORIZED REPRESENTATIVE.

**READ ALL INSTRUCTIONS BEFORE PROCEEDING**

Tool List	Quantity	Tool List	Quantity
Torque Wrench, Ft. Lbs.....	1	Torx Driver 47 IP.....	1
15mm (Deep) Socket.....	1	10mm Wrench.....	1
Phillips Screwdriver.....	1		

**! WARNING**

**Prevent battery explosion that could result in severe personal injury or death, keep all smoking materials, open flame or sparks away from the batteries.**

**Be sure that the key switch is off and all electrical accessories are turned off before starting work on vehicle.**





**Always wear a safety shield or approved safety goggles when working on the vehicle.**

**Bag Cover/Rain Curtain Installation**

1. Wrap the sleeve around the strut and lock the three snap buttons. See Figure 3, page 2 of 2.
2. Strap the upper most bracket on the bag cover assembly around the strut and tighten nut onto the threaded stud using a phillips screwdrive and a 10mm wrench. See Figure 3, page 2 of 2.
3. Remove the (2) two flange nuts and (2) two Torx screws on the sweater basket. See Figure 2, page 2 of 2.
4. Align the bag cover assembly bracket with the holes on the sweater basket then, replace the Torx screws and flange nuts — tighten by hand. See Figure 2, page 2 of 2.
5. Continue to the opposite side and repeat steps 1 through 4.
6. Tighten flange nuts (both sides) to 4 – 6 Ft. Lbs. (6 – 8 Nm) torque. See Figure 2, page 2 of 2.

**! CAUTION**

**Low end torque values recommended.  
-DO NOT OVER TORQUE-**

TITLE <b>Instructions, Bag Cover</b>						REV <b>D</b>
			DRN BY DATE	REV BY REV DATE	KEH 20OCT15	<b>A</b> DRAWING NO. 606115
A Textron Company			1 of 2			
Textron Specialized Vehicles, 1451 Marvin Griffin Rd., Augusta, GA. 30906-3852 Technical Assistance & Warranty Phone: 1-800-774-3946 Service Parts Phone: 1-888-438-3946						

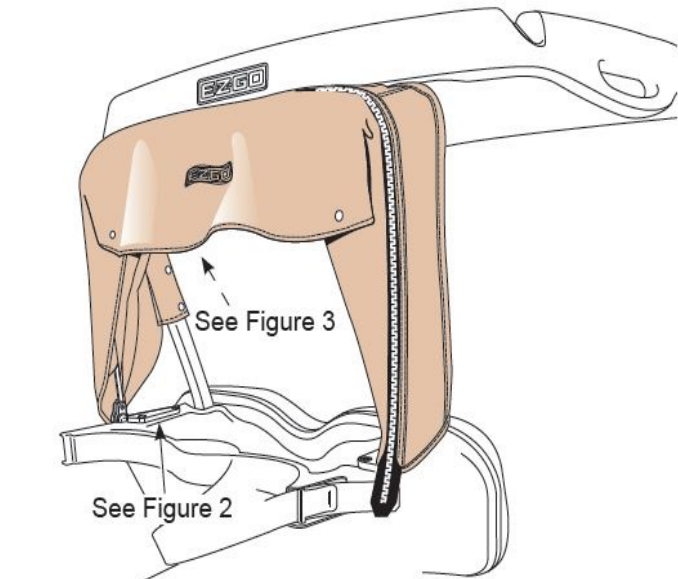

**Figure 1**

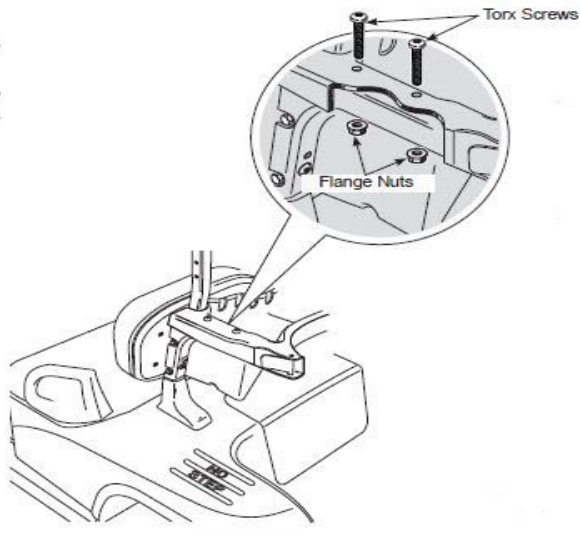

**Figure 2**

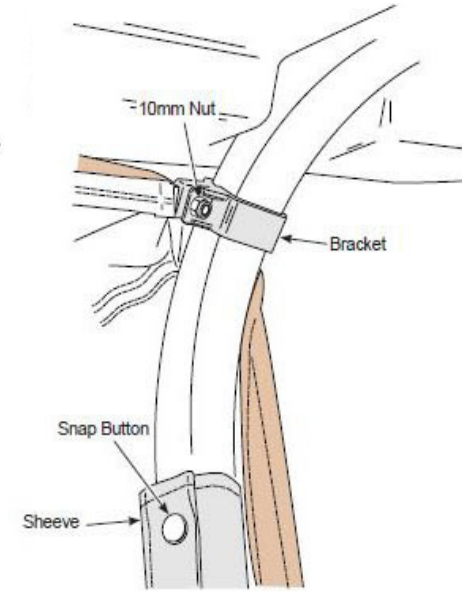
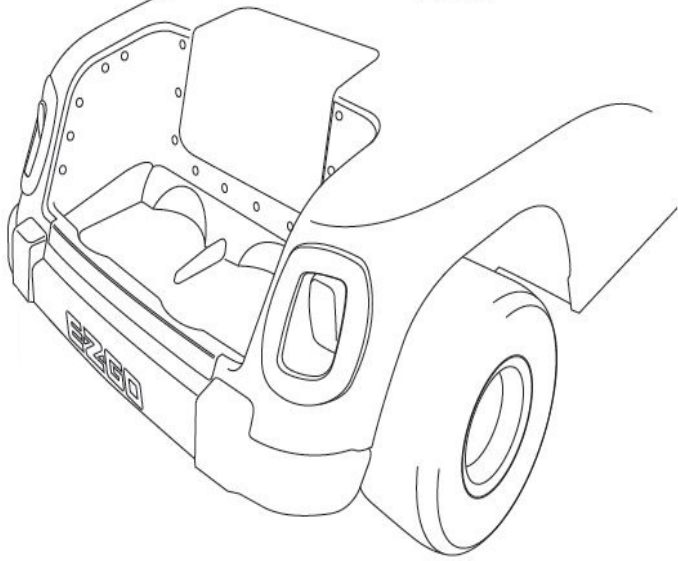

**Figure 3**

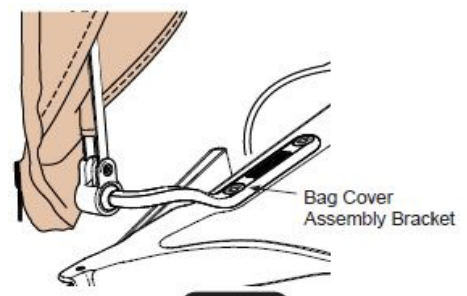

**Figure 4**

TITLE **Instructions, Bag Cover** REV **D**



DRN BY DATE	REV BY REV DATE	KEH 20OCT15	<b>A</b>	DRAWING NO. 606115	2 of 2
Textron Specialized Vehicles, 1451 Marvin Griffin Rd., Augusta, GA. 30906-3852 Technical Assistance & Warranty Phone: 1-800-774-3946 Service Parts Phone: 1-888-438-3946					